

## **Micro-Electromechanical System Based Electronic Capsules (MEMS) Aimed At Optimizing Drug Delivery To The Human Body**

Saman Hosseini

Ph.D. Mechanical Engineering, Mechanical Engineering Department, University of Toronto, Toronto, ON, CANADA.

[Saman.Hosseini@gmail.com](mailto:Saman.Hosseini@gmail.com)

**Abstract:** In light of rapid advances in medical technology, we have witnessed significant transformation in drug/medication delivery mechanisms as well as its efficiency in recent years. The utilization of Micro-Electromechanical System (MEMS) has achieved and accomplished valuable success in optimizing treatment as well as administering medication. Specifically, there has been fewer side effects, effective medication delivery, ease of use, lower cost as well as patient satisfaction. Therefore, in this study, with the objective of becoming familiarized with this treatment system, we have endeavored to analyze capsules based on electromechanical technology. Moreover, the review approach and the library method were utilized. The study's findings revealed that by using this system, drugs can be effectively administered at arbitrary rates and well-controlled by microfluidic platforms via integration, planting, localization, automation and precise control of various parameters. Essentially, this micro-device can efficiently reach all the target areas. Accordingly, these features make repeatable/reproducible and on-demand drug delivery possible. Hence, the performance of all of them can be viewed as positive as well as a suitable alternative in treatment and administering medication to a specific area of the body.

[Saman Hosseini. **Micro-Electromechanical System Based Electronic Capsules (MEMS) Aimed At Optimizing Drug Delivery To The Human Body**. Life Sci J 2023;20(6):43-56]. ISSN 1097-8135 (print); ISSN 2372-613X (online). <http://www.lifesciencesite.com>. 06. doi:[10.7537/marslsj200623.06](https://doi.org/10.7537/marslsj200623.06).

**Keywords:** Medication/Drug Delivery System, Electromechanical Systems, Timer Capsules, Robotic Capsules, Remote-Controlled Capsules, Implantable Capsules

### **Introduction**

Since its inception in the early 1950s, micro-electromechanical system technology has been rapidly growing. Taking into account that utilization of micro-electromechanical systems significantly reduces costs and increases production, hence it is natural for this industry to have attracted a great of attention in today's world. This system's features are inclusive of small dimensions, low weight and efficient energy consumption. As a consequence, the system is widely utilized in various fields such as medicine, medical engineering, administering medication, diagnosis, imaging, etc. (Khayeri, 2018).

In recent years, applications of nano-electromechanical & micro-electromechanical technology (NEMS-MEMS), commonly referred to as bio-MEMS systems, have become increasingly popular. This technology has prevalent applications in both diagnosis and treatment of diseases and tissue engineering. Furthermore, in the last several years, with accelerating research activities in this field, some of these applications have also become commercial. Via deploying these systems, the process of escalating the

production of micronutrients for medical applications can be greatly speeded up. Using MEMS and NEMS technology, miniaturized medical devices possess high performance capability in estimating multiple basic needs such as controlled drug delivery irrespective of side effects. In recent years, the progress of these systems, vis a vis Transdermal Drug Delivery (TDD), has been quite significant (Madan-Pasandi, 2016).

Recently, interest in optimizing drug therapy has also increased with the study of Regional Drug Absorption (RDA) (Wilding, 2000). The utilization of MEMS for comparative drug delivery represents a new and emerging field of study. MEMS is a powerful platform for delivering strong therapeutic drugs, the temporary administration of which is critical to their effectiveness. Their effect becomes naturally enhanced by the human body. Due to its flexibility and potential programmability, MEMS provides superior control over drug delivery compared to traditional polymer-based systems (Amer, Badawy, 2005).

MEMS technology enables successful shrinkage/miniaturization of micropumps for administering drugs and enables active delivery of

liquids from single or multiple tanks. Due to their dependence on mechanical moving parts in fluids as well as high energy consumption, implantable drug delivery devices that rely on micro pumps are known by their primary limitations, namely low delivery rates and inferior reliability. Drug delivery devices characterized by multi-tank/reservoir architectures based on electrical stimulation mechanisms provide a more reliable platform. These devices can usually rely on thermal electrical stimulation/excitation to rupture the tank sealing membrane (induced by electrical potential), and facilitate drugs distribution freely in the target area (Maloney, 2005).

As a consequence of the enhancing progress in this sector, in this research, the characteristics of the above-mentioned micro-electromechanical capsules will be elucidated and their capabilities and benefits will be assessed and evaluated.

### 1-Remote-Controlled Capsules (RCC)

These capsules are widely used in the pharmaceutical industry and in specific areas of the body such as the gastrointestinal tract. To date, several studies have been conducted on how Regional Drug Absorption (RDA) is accomplished utilizing Remote-Controlled Capsules (RCC) (examples include: Rog & Associates, 1996; Gardner & Associates, 1997; Welding & Prior, 2003). Additionally, significant improvements have been made during these studies. Very important parameters have been stipulated for the evaluation of remote-controlled capsules, among them reliability, capsule size, drug tank volume, duration of use, drug delivery, and residual volume ratio (Xianti & Associates, 2009).

In the present study, a new remote-controlled capsule based on microelectronic mechanical system (MEMS) technology is defined and described. The objective was to introduce a new micromachine propellant that converts the solid propellants in chemical energy into thrust energy.

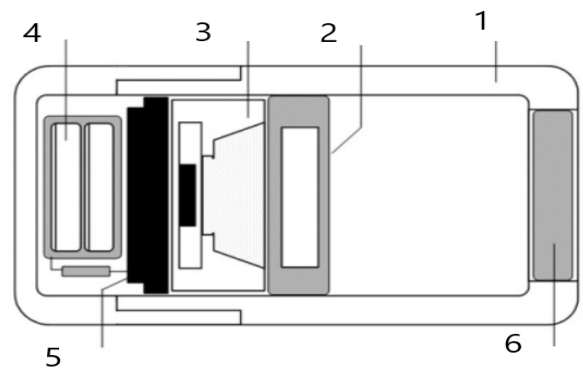
This microcomputer consists of two main components, the igniter and a combustion chamber. As the remote-controlled capsule reaches the target area, an external RF signal can activate it. The propulsive force created by the propulsion pushes the piston forward with great acceleration and removes the drug completely out of the dosing tank. Since this increased pressure is the gas (not the mechanical force of the spring) acting on the piston, hence, the drug reflex is effectively eliminated. Multiple experiments and laboratory tests have revealed that this newly-integrated remote-controlled capsule works well and can be a promising alternative to Regional Drug Absorption (RDA) studies (Xianti & Associates, 2010).

## 2-System's Design & Construction

### 2.1-Structure Of Remote-Controlled Capsules (With Micro-Propulsion)

The micro-propulsion is designed to be embedded in a remote-controlled capsule. The microcomputer consists of a cellular module, a control unit and a microstructure, an extruder, a medication tank/reservoir of up to 0.7 ml, a sealed silicone plug and a polycarbonate-made, environmentally-friendly shell.

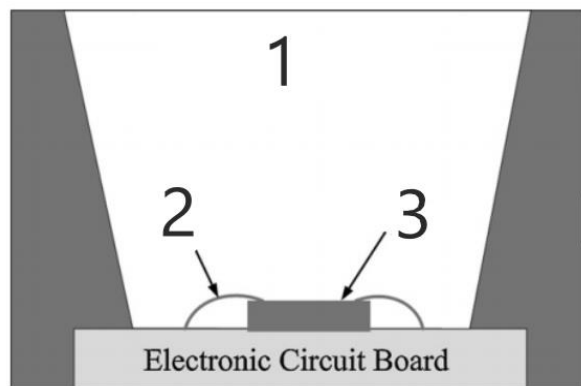
Figure 1 is a geometric image of a remote-controlled capsule. When the capsule reaches a predetermined part of the body (such as the intestines), it is activated by applying a 330 MHz radio frequency signal emitted by a remote-controlled device. The internal antenna receives the signal and utilizes it for electronically controlling the unit, in turn triggering the microprocessors.



**Figure 1:** Remote-Controlled Capsule's Structure (Xianti & Associates, 2010: 228)

Image Description: 1-Polycarbonate Capsule Body, 2-Piston, 3-Micro-Propulsion, 4-Cell Module 5-Electronic Control Unit, 6-Sealed Plug

As a stimulus for drug release/delivery, the micro-propulsion system consists of a combustion chamber (integrated with a nozzle), a micro-igniter and on-board electronics. Figure 2 displays a schematic diagram of a single micro-propulsion. The wall of the combustion chamber is made of highly-pure copper (Cu) with precision metalworking, and the hollow area has the following dimensions: height=4.7 mm, side slope angle=12°, and diameter=4&6 mm, one low circuit board sealing the housing and wires (dimensions: 500\*100µm) located in its center.



**Figure 2:** Schematic Diagram Of A Single Extruder (Xianti & Associates, 2010: 228)

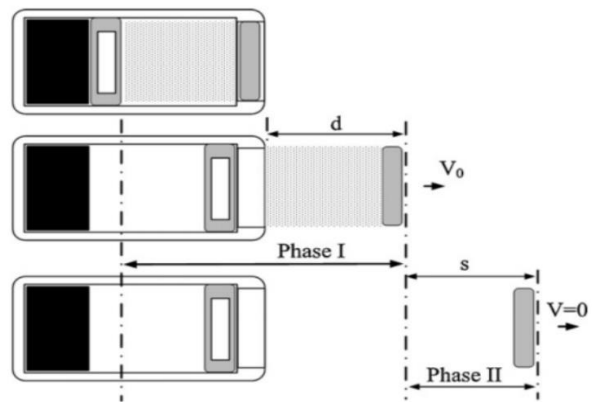
Image description: 1-Combustion Chamber, 2-Wire, 3-Micro Igniter

### 2.2-Micro-Drift's Mechanical Analysis

Since the feasibility and reliability of the system is primarily contingent on the performance of the micro-drift, it is therefore essential to determine the optimal mass of the propulsion considering it impacts the mechanical performance of the remote-controlled capsule during operation and pursuant to medication delivery.

Upon microwave combustion, the operation of the remote-controlled capsule can be described in two separate phases. Initially, the plug comes out of the capsule and the piston moves forward at a constant speed. Next, the piston is stopped by the drug's dosage aperture. In the second stage, the sealed plug continues to advance on its own before its energy is discharged by the resistance in the gastrointestinal tract. It is presumed this mechanism functions without gravity (negligible gravitational impact on the system). Figure 3 shows the drug delivery process.

Phase 1 is governed by the law of internal ballistic energy conservation, where from the correlation between propulsion mass and the maximum velocity of the sealed plug is obtained. Some basic assumptions are made during the operation: 1-The viscous tension ensuing from the liquid formula applied to the piston is ignored. 2-The sealed piston and plug will have speeds equivalent to the drug solution in the tank. 3-Intestinal water resistance is ignored when the sealed plug is removed from the remote-controlled capsule. 4-A small amount of energy storage in DDNP is considered insignificant compared to black powder in the combustion chamber.



**Figure 3:** Drug Delivery Process Via Remote-Controlled Capsules (Xianti & Associates, 2010: 228)

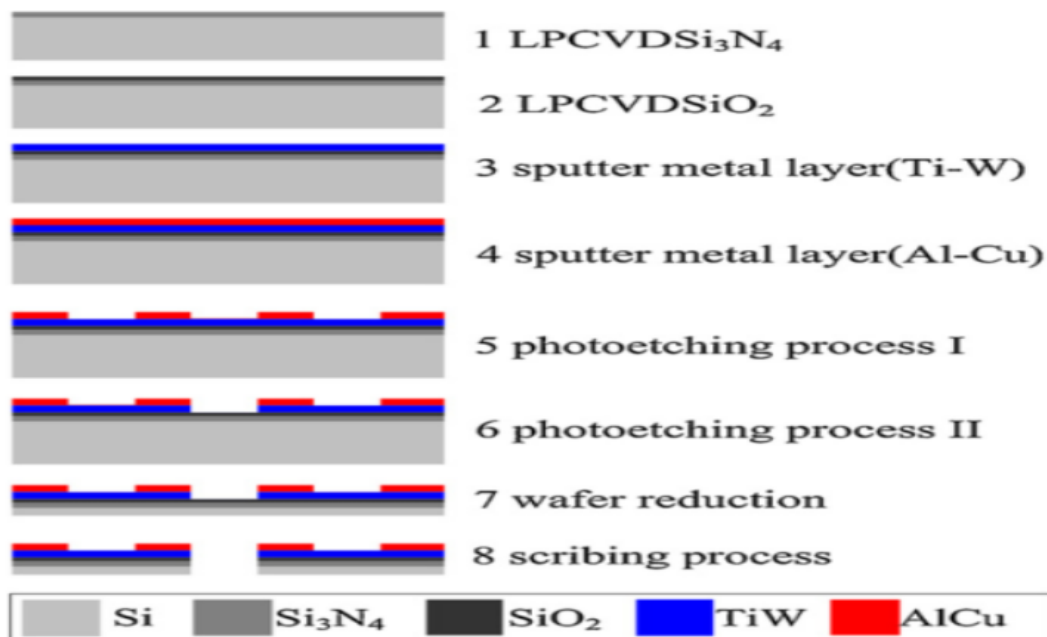
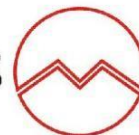
Due to frictions between: 1-The piston and the inner wall of the capsule & 2-Between the sealed plug and the inner wall of the drug dose chamber aperture; the energy consumed by the resilient friction is calculated separately.

**Table 1:** Specifications Of Remote-Controlled Capsules (Xianti & Associates, 2010: 229)

Parameter	Symbol/Unit	QTY
Piston Mass	$M_1$ (g)	0.85
Medication Amount	$M_2$ (g)	0.70
Mass Of Sealed Plugin	$M_3$ (g)	0.05
Piston Friction	$f_p$ (N)	0.50
Plug Friction	$f_s$ (N)	0.50
Plugin Radius	$r$ (mm)	2.00
Combustion Chamber Volume	$v_c$ (cm <sup>3</sup> )	0.09
Drug tank Volume	$v_r$ (cm <sup>3</sup> )	0.70
Total Volume ( $V_c+V_r$ )	$v_g$ (cm <sup>3</sup> )	0.79

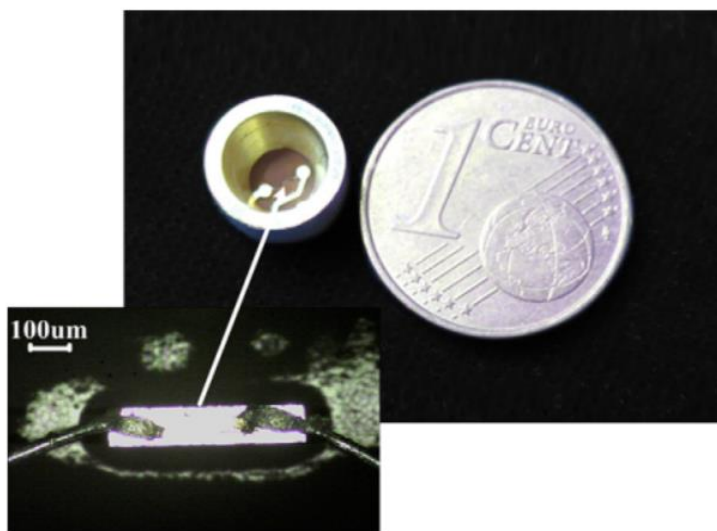
### 2.3-Micro-Thrust's Construction & Assembly

The micro-igniter is fabricated via the MEMS processing technology. The general flow diagram for its microstructure can be observed in Figure 4. Low pressure chemical vapor deposition (LPCVD) was utilized to induce thin layer silicon compounds on the substrates (as demonstrated in steps 1 & 2). Two metal layers were sprayed on the layers. As revealed in steps 3 & 4, the previous coatings were selected with a Ti-W thin layer technique to comply with the requirements of the device. Resistant and lead-made areas were modeled in a certain order (lithography-wise), and ultimately, a segment with a certain thickness was established and its microvessels were separated.



**Figure 4:** Microfiber Ignition Fabrication Process (Xianti & Associates, 2010: 229)

For micro-thrust assembly, the micro-igniter is first connected to the electronic circuit board with the help of insulating adhesive and connected to it by ultrasonic connection process with Ø30-meter silicon-aluminum wires. Thereafter, the board is sealed on the base of the combustion chamber utilizing medical device adhesive. Second, 1 mg of DDNP was placed on the micro-ignition as an explosive. During the test, a certain amount of black powder was added to the combustion chamber. The filling process of the black powder was performed in a steam hood and the operator wore goggles and protective gloves during the test (due to safety concerns). In Figure 5, an image of a single propulsion-less micro-drift can be viewed.

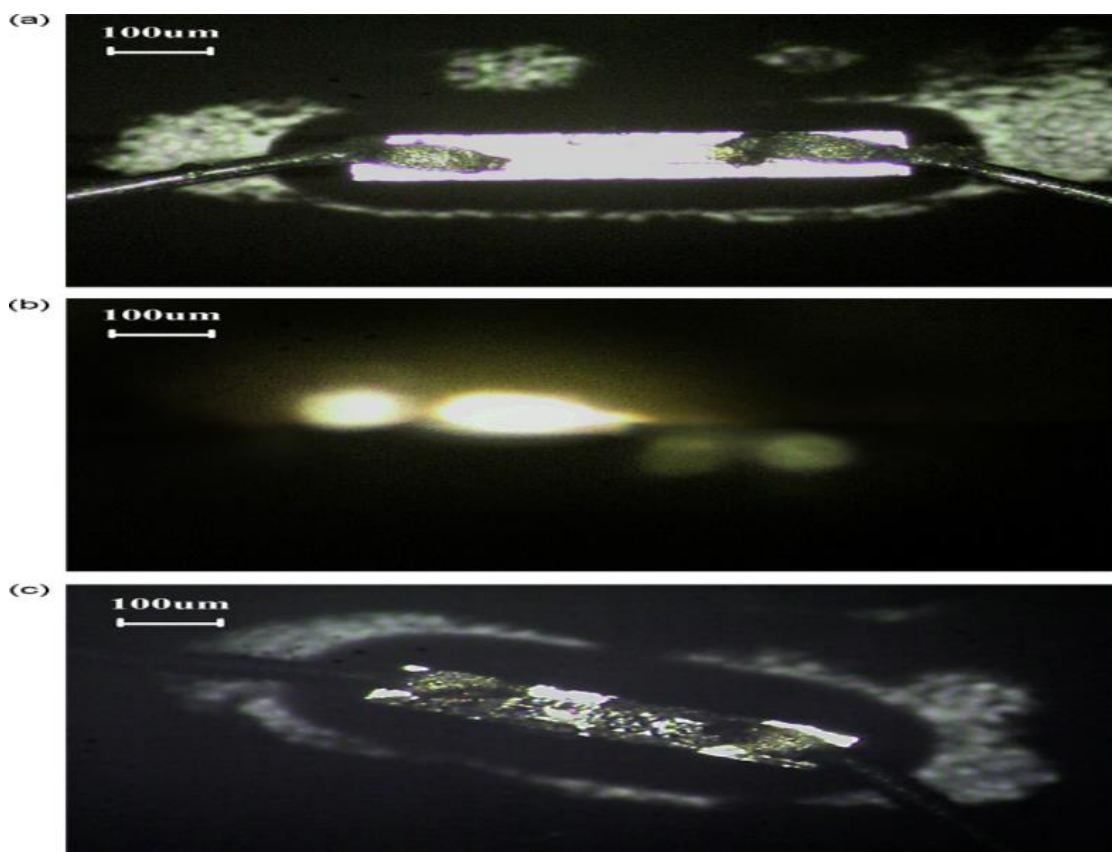


**Figure 5:** A Single Propulsion-Less Micro-Drift (Xianti & Associates, 2010: 230)

Figure 6 shows images of the spark plug before, during and after combustion. The average combustion potential was 3.0 V with standard deviation (SD) of 0.045 V. The average micro-igniter power consumption was 166.08 MW with SD of 3.31 MW. During the combustion test, the microtraster required 3.0 volts to heat the micro-combustion, and its power consumption was approximately 166 MW, which could be supplied by two button cells in the cell module of the remote-controlled capsule.

Overhauls and major repairs of the remote-controlled capsules revealed that most of the drug solution leaked from the tank into the plastic tube. Obviously, the sealed plug is no longer inhibited by the aperture due to the thrust applied by the piston. Each capsule in the three groups had a sealed plug and the piston made significant but varied displacements, This contradicts previous theoretical analysis which showed that the plug, the piston, and the drug solution in combination must be at the same distance before the piston reaches the piston inlet. This phenomenon is accompanied by the assumption and calculation that phases 1 & 2 both occurred under zero gravity conditions.

Continued test findings indicated that after the sealed plug is removed from the capsule, the solution is discharged from the tank by gravity, which also makes the subsequent propulsive force produced by the piston inaccessible to the sealed plug. In the other groups, the piston made the maximum displacement and quickly removed the drug and the sealed plug from the capsule. The maximum displacement of the sealed plug was 60 mm, which compliant to the theoretical analysis did not exceed the safety limit of 66 mm (phases 1 & 2).



**Figure 6:** Images Of Micro-Igniters Before, During & After Combustion. (A), Non-Propulsion Micro-Drift (B) During Combustion & Ignition (C) After Successful Combustion (Xianti & Associates, 2010: 230)

Figure 7 is an image of a remote-controlled capsule assembled with a microtraster (described in this study). Pursuant to eighteen drug delivery experiments, the corresponding displacement of the plug was sealed and the piston for each path was obtained (stipulated in Table 3). It is similar-sized or even smaller than a regular oral capsule and therefore no problems are expected as far as consuming/swallowing them.



**Figure 7:** Exterior Image Of Remote-Controlled Capsule (Xianti & Associates, 2010: 231)

Newer activation mechanisms for remote-controlled capsules are possible during laboratory studies. Nevertheless, further optimization of the device assembly process is requisite toward reducing device failure. Prospective future research will be primarily focused on mechanical algorithm improvement, micro-extruder thermal analysis and experimental restart.

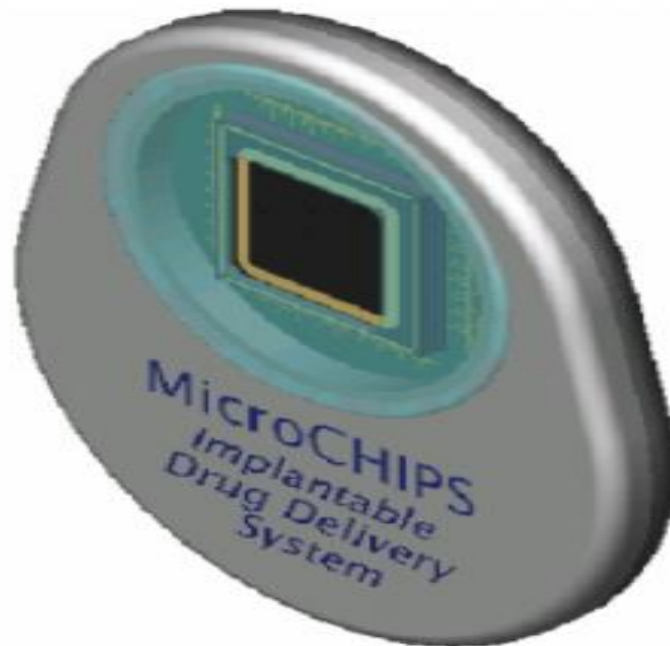
### 3-Implantable Drug Delivery Capsules

In essence, implantable drug delivery systems consist of two categories: 1-Biodegradable & 2-Non-Biodegradable systems. For both biodegradable and non-biodegradable IDDS, most key components are typically made of polymeric materials. In addition to drug delivery, the components may have other functions such as structural support and enhanced biocompatibility stability. Toward this objective, there are currently multiple implantable drug delivery tools founded on microstructure or nanostructure technologies are being manufactured. (Lothar & Associates, 2014: 2)

Even though oral delivery is the preferred consumption method for most medications, to overcome drug delivery constraints, other methods have also been developed via utilizing pulmonary devices, infusion, implantation, etc. For instance, most macromolecules are either digested in the gastrointestinal tract or not well-absorbed into the bloodstream. Oral administration may also be unsuitable for medications requiring rapid onset of effect/action. Similarly, pulmonary contraptions, such as inhalers, require that drugs be absorbed into the bloodstream from the lungs.

Fully implantable drug delivery tools are preferred and desirable when and where alternative methods of delivery are not possible. These devices allow medications to be stored/kept in a space and delivered at effective rates without the need for the patient's compliance.

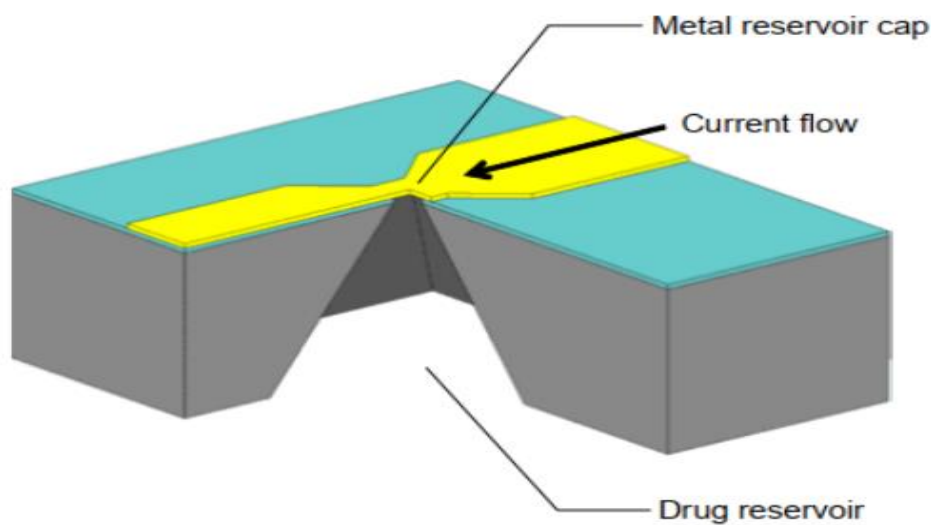
Advanced implant systems can be used to precisely control the speed of drug delivery. Some therapies require the continuous release of medications to maintain the treatment level for extended periods. The microchip system is able to deliver multiple drugs at their optimal therapeutic levels. The implant delivery system or IDDS, observable in Figure 8, is based on a tiny silicon chip containing several medication-filled tanks. The chip is connected to a titanium edifice containing a battery, a control circuit and a telemetry. The drug chip and the titanium case are hermetically sealed and connected by a ceramic substrate with metal joints.



**Figure 8:** Image Of An Implantable Drug Delivery System (Malony, 2003)

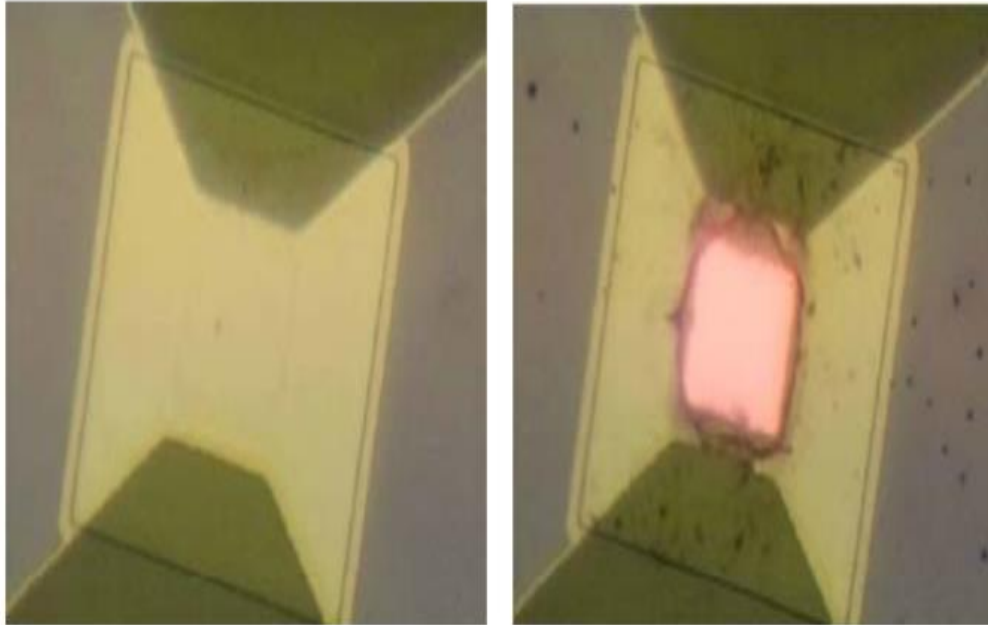
IDDS communicates with an external manual controller via wireless transmission. A medication regimen can be transferred to the implanted device through this link, allowing the tanks to be opened at specified intervals without the need for further communication. Moreover, the tanks can be opened by the controller as desired. Because complex doses can be administered automatically, the burden on the patient is greatly reduced compared to other drug delivery methods.

The drug chip consists of a silicone substrate where dozens or even hundreds of tanks are engraved/implanted. A single tank can be seen in Figure 9. MicroCHIPS release/delivery technology deploys an electrothermal mechanism acting similar to an electric fuse.



**Figure 9:** Unitary Tank On The Drug Chip (Malony, 2003)

The drug tanks are initially covered by a thin metal cap as shown in Figure 10. To release/deliver the drug, voltage is applied to the cap and it quickly heats up to the breaking point. Activation occurs in less than 50 microseconds, minimizing tissue and drug exposure to high temperatures. We selected a miniaturized silicon chip to hold the drug and release/deliver it. Hence, initially, standard processes such as physical and chemical vapor deposition, reactive ion engraving, and bonding in the semiconductor industries and MEMS are defined comprehensively and thoroughly. Second, single crystal silicon, providing a strong, hermetic substrate, can be chemically etched utilizing wet or dry processes. Third, photolithographic-based processes allow the fabrication of a group, wherein each device is simultaneously fabricated on a thin base with a micron tolerance.



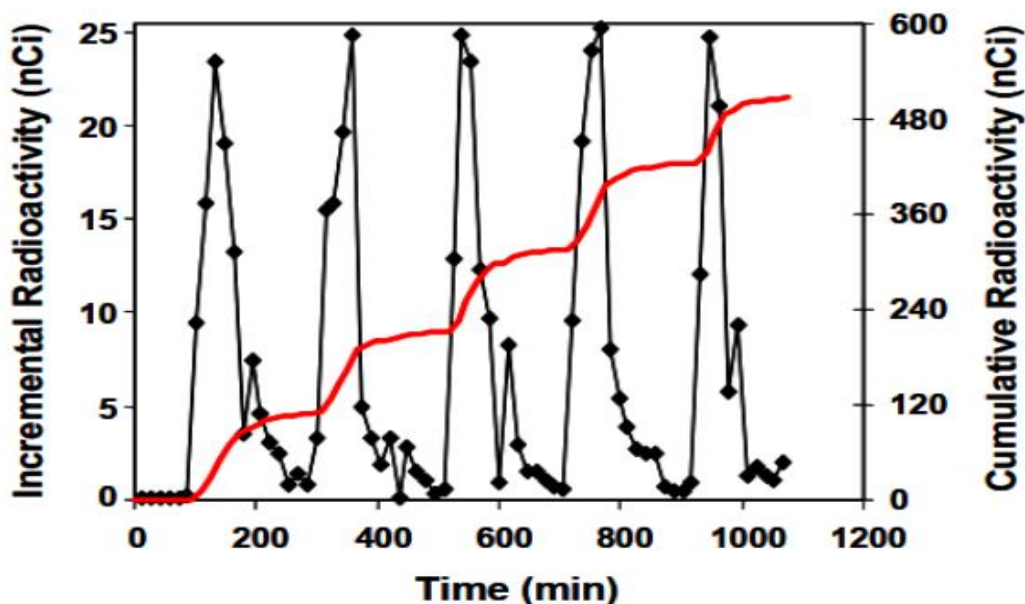
**Figure 10:** Tank Cap Before & After Activation (Malony, 2003)

The silicon chip is filled using an automated station with machine vision capability. Because sterilization methods such as autoclave are not compatible with temperature-sensitive medication, the filling process is performed in an aseptic environment. The tanks are then hermetically sealed.

Biocompatibility and biostability issues are key and significant in designing an implantable device. In this system, materials come in contact/touch with the body, including materials such as titanium and gold (prevalently-utilized in the implantation industry). To demonstrate the biocompatibility of micronutrients (like silicon & silicon dioxide), laboratory studies that assessed and analyzed the physiological response to microstructure drug chips were performed. Post-implant response is similar to implant control responses and is industry approved.

Biostability is enhanced during the life of the device by utilizing functional and usable metals and ceramic layers that protect the device during implanting. During the material evaluation period for implanting, the implanted devices were examined and assessed optically, electrically and with a Scanning Electron Microscope (SEM) to detect any implantation-induced changes. In addition, laboratory experiments were performed by exposing the drug chip to ionic and oxidative solutions and were simulated in an existing living environment.



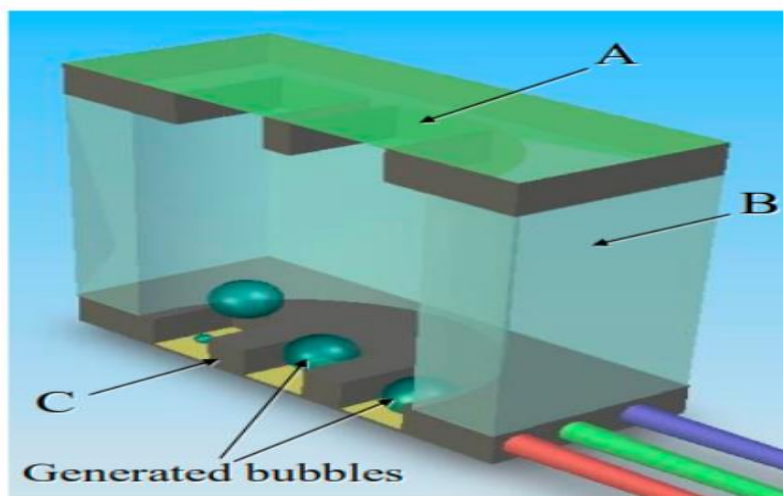


**Figure 11:** In-Body Release/Delivery Profiles (Malony, 2003)

Figure 11 illustrates the medication release/delivery success rate in the laboratory as well as live environment utilizing the above-described technology. The devices were tested by emitting radiolabeled compounds and therapeutic drugs and via releasing/delivery of detection by scintillation counting and liquid chromatography. Periodically and at certain intervals, the PBS was replaced by inlet and outlet pipes and the collected fractions were analyzed.

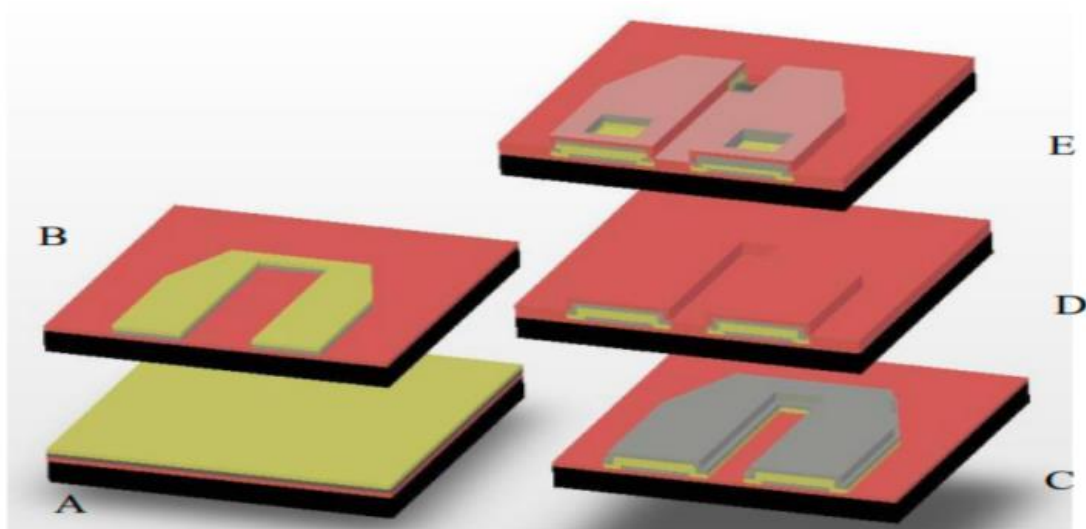
These experiments proved that drug delivery is reliable and repeatable/reproducible, and implant delivery devices provide a viable solution to specific medication delivery problems. Moreover, in many instances, they do not have the limitations and constraints of other drug delivery methods.

There is also another device for implantation of drug delivery capsules. The modular structure of this device is shown in Figure 12. It consists of three main layers. In the first layer, there is a tank where the medication is stored. Second is a membrane layer that closes and insulates the tank, and finally third, is a local layer where from the medication is removed and a provocation/irritation layer is created in which a bubble is formed. The primary materials in this device are all biocompatible and include silicon, nitride, silicon dioxide, gold and titanium.

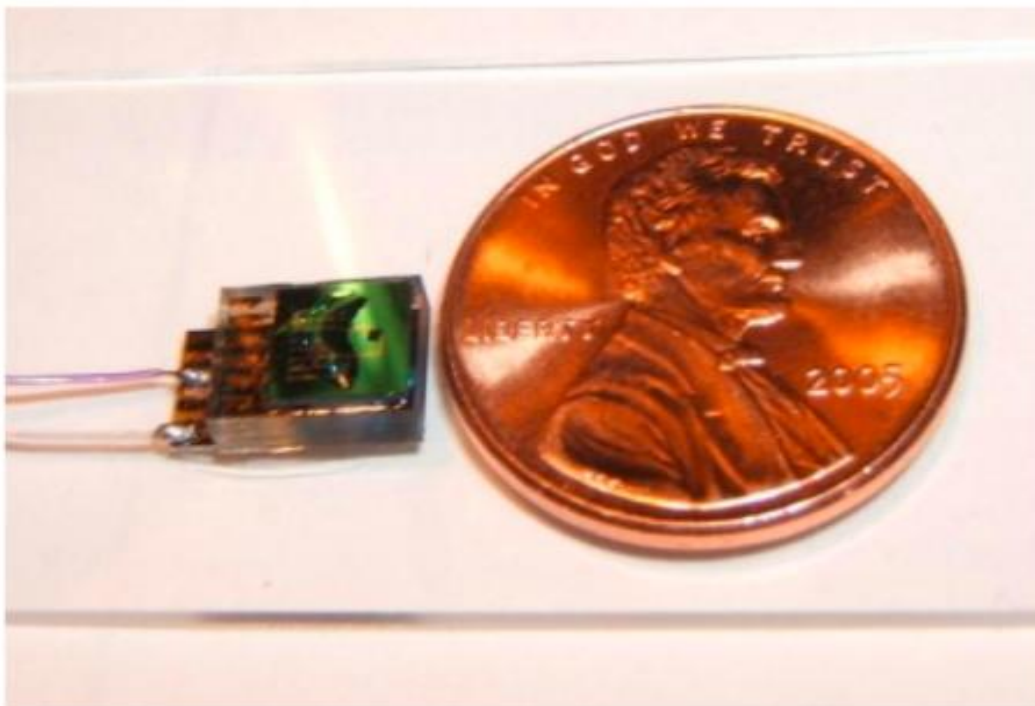


**Figure 12:** Cross-Sectional View Of The Device & Its Three Layers: A) Membrane B) Tank/Reservoir C) Stimulation (Elman & Associates, 2009, 14)

The manufacturing process of this device was performed in three independent stages. The base layer was made utilizing micro machining technology and consists of a spectrum of SIN with a gold layer acting as a sensor. The device actuator is fabricated via using micro-machining technology (in 100 mm & under SCS layer). The device tank is produced (2.25 mm thick & 7740 part/component). The actuator section's order of construction is observable in Figure 13. The final image of the made capsule can be seen in Figure 14.



**Figure 13:** Fabrication Sequence Of Excitation/Stimulation Layer, Composed Of: A)  $\text{SiO}_2$ , Titanium, Gold B) SCS, Electrode & Resistance Definition C) Gold Encapsulation D) Silica E) Vias Electrodes & Exposure To Titanium (Elman & Associates, 2009: 15).



**Figure 14:** Final Shape Of Manufactured Capsule (Elman & Associates, 2009: 15)

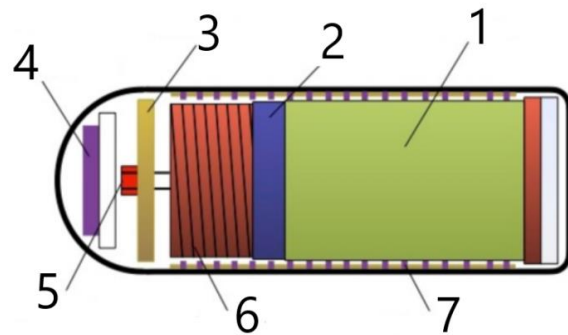
Overall three tests were performed to evaluate the performance of the device. In the first experiment, the electrical properties of the device under laboratory conditions were analyzed. This test quantitatively determined the electricity consumption level and qualitatively the drug delivery rate. In the second test, the delivery level/amount is quantified via using anti-diuretic hormones. In the third experiment, the stimulation mechanism effects on medication decomposition was determined utilizing high-pressure liquid chromatography. The test findings revealed that this of drug delivery method is a technology platform that can be deployed and utilized for multiple medical applications. Implantable capsules based on microelectromechanics are ideal for those ailments requiring urgent, immediate and outpatient treatment.

#### 4-Robotic Capsules

The introduction of capsular endoscopy two decades ago marked the beginning of the "Small Bowel Revolution." Since then, the rapid evolution of microtechnology has allowed the development of drug delivery systems (DDS) designed to cope with certain particular requirements not met by standard drug delivery. To overcome the complex anatomy and physiology of the gastrointestinal tract, several DDSs have been developed, including innovative medication delivery mechanisms and anchor system prototypes/designs devised (eventually to be produced), enabling targeted therapy.

Capsules on the market vary in size and structure (deepening on the manufacturer), however, they all follow the same basic principles. They usually weigh between 3-4.5 grams and are approximately 26x11 mm in size. This compact casing has a recorder or data transmitter, white light emitting diodes, magnifying lenses and high-speed photography, as well as an internal battery.

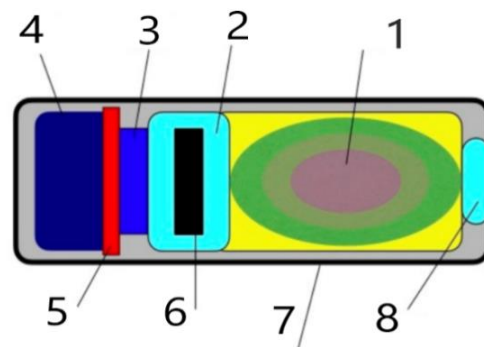
Figure 15 displays a magnetic field-based mechanism introduced by the input capsule (Phaeton Research), introduced in Nottingham, UK. This 32x11 mm capsule contains a 1-ml-capacity tank and is equipped with a spring mechanism able to be activated by a magnetic shock. An internal heating element opens the capsule and expels/delivers the drug quickly with a piston. Slowly This system's features are quite similar to the @InteliSite capsule.



**Figure 15:** Final Design Of Inlet Capsule (Cortegoso Valdivia & Associates, 2021: 4) Inclusive Of: 1-Drug Receptor, 2-Piston, 3-Electronics, 4-Tracking System, 5-Spring Trigger, 6-Stimulus Spring For Medication Exit , 7-Radio Frequency Antenna

In 2010, Pi & Associates proposed a solid propeller micro-propulsion for the actuator assembly of an RCC remote-controlled capsule (Figure 2). In this capsule, sufficient gas pressure is generated to discharge/empty the drug tank utilizing a micro-incendiary as a vital component of the shrinking propellant, which is in fact more diazodic and contains phenol as the explosive agent and black powder as the propellant.

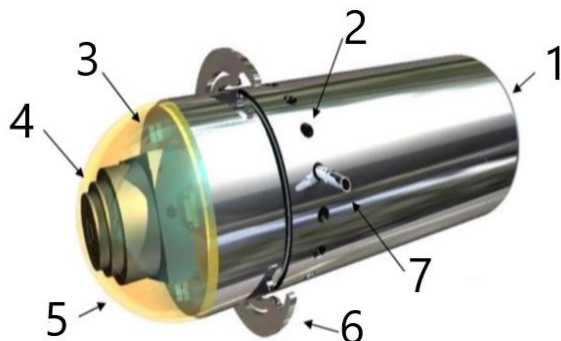
The research's findings demonstrated that in this capsule, 166 MW of power consumption led to successful combustion with complete and rapid release/delivery of the drug, and this success was accomplished when there was a 16-20 mg propulsion. Therefore, this system can be a promising alternative to specific DD in the human gastrointestinal tract. The issue with these two models is their lack of imaging guidance.



**Figure 16:** Remote-Controlled Capsule (RCC) Contour (Cortegoso Valdivia & Associates, 2021: 4), Which Includes: 1-Drug Solution, 2-Piston, 3-Mobility Device, 4-Cell Button, 5-Remote Control Unit, 6-Magnetic Market, 7-Shell, 8-Silicone O-Ring

In 2013, Woods & Constantino presented their concept for a micro-robot platform with a maximum volume of 3.0 cubic centimeters, equipped with pH, temperature and pressure sensors as well as a metal oxide semiconductor (CMOS) for real-time image guidance. The design consisted of two subsystems: micro-positioning (a mechanism wherein 1 ml of targeted medication is delivered) as well as an inhibitory mechanism, responsible for holding the capsule in a net against gastrointestinal peristalsis. Of course, the overall volume and geometry of the system is greatly influenced by the constraints imposed by the ingestible size. Research in this area has indicated that 3.0 cubic centimeters can be swallowed. The platform depends on the operator to remotely deploy the anchor mechanism.

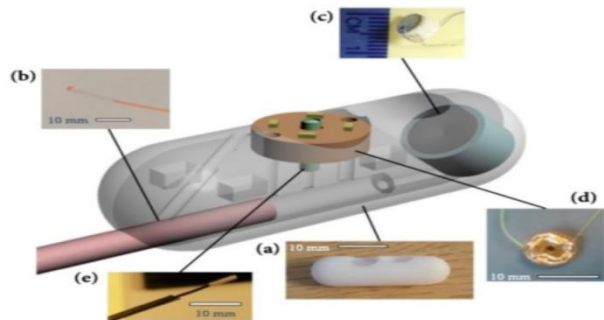
In addition, the operator can control the rotation and advancement of the needle for topical injection (Figure 17). In this mechanism, the needle can be placed in the 360° range. The authors projected that the system could be beneficial for diagnosis and treatment of gastrointestinal pathologies such as SB Crohn's disease and/or tumors.



**Figure 17:** A Prototype Capsule With Integrated Anchor Mechanism & A Targeted Drug Delivery System (Cortegoso Valdivia & Associates, 2021: 4), Which Includes: 1-Cover, 2-External Port, 3-Led Lighting, 4-Coms Camera, 5-Primary Lens, 6-Stop Mechanism, 7-Distribution Needle

In 2017, the SonoPill team introduced a new concept of a prototype device called SonoCAIT (Figure 18). This capsule (dimensions: 10×30 mm) has four main components required for targeted DD through ultrasound. Therefore, it has a centralized American converter, a DD channel, a video camera and a light source. Initially, to facilitate power and indicator transmission, it was recommended that upcoming versions include wireless communication and power delivery. This could be accomplished via embedding an antenna in the capsule shell to maximize space inside the capsule.

The US-powered system (4 MHz) consisted of a self-centered bowl with an outer diameter of 5 mm and a DD channel consisting of perforated polyethylene pipes (outer diameter: 0.96 mm & inner diameter: 0.58 mm). Video recording is provided by a CMOS camera (resolution: 220x224 pixels). The illumination of this system is also provided via a printed circuit board (PCB) with four 40 MW LEDs (OSRAM Opto Semiconductors GmbH, Germany). The PCB has a hole in the center (diameter: 1.5 mm) enabling the camera to pass through.



**Figure 18:** An Initial Capsule For Targeted Ultrasound-Mediated Drug Delivery (Cortegoso Valdivia & Associates, 2021: 4), Wherein: A) Body Of capsule, B) Connection To Power Cables & Drug Delivery Channel, C) Ultrasound Probe, D) Light Source & E) Miniature Camera

Therefore, consistent with the topics and subjects discussed, it can be stated that robotic capsules are on their way and will likely become quite prevalent, and as a consequence, the utilization of capsules only as diagnostic imaging devices will soon become a thing of the past.

### 5-Drug Delivery Capsules With Timers

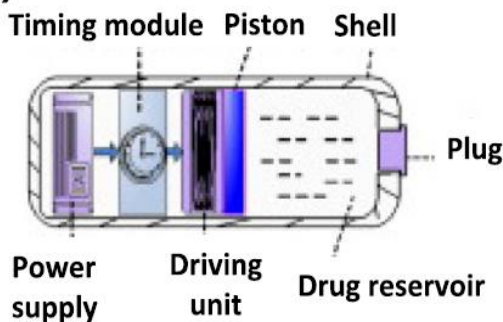
With technological development enabling the manufacturing of MEMS-based micro devices, the drug delivery system has experienced new and notable successes. Moreover, timers have also been utilized in drug capsules since timers allow and enable predetermined levels of medication concentration in the bloodstream.

Using micro-tank systems consisting of one or more drug tanks for temporary storage, small-scale drug loading and delivery operations are provided in controlled media. They provide more accurate drug delivery rates and allow physicians to actively initiate, modify, and stop drug delivery at desired areas of the body in an interactive manner. Recently, the development of micro-tanks-based systems for controlled drug delivery has demonstrated potential for difficult and challenging medical applications (such as ocular/eye diseases).

These systems can be classified into two main activation mechanism categories (active & inactive modes). Stable and long-lasting drug delivery profiles can be achieved in the inactive state, while the time and level of delivery can be precisely and quickly controlled in the active state. Inactive mode for drug delivery is applied when the release/delivery rate is predetermined (commonly-utilized in self-regulating drug delivery systems).

Among the MEMS-based controlled drug delivery devices is the one proposed by Zhuang & Associates (2011), actuated by a piston (utilized for gastrointestinal tract drug delivery). This device (length: 30.0 mm; outer diameter: 10.6 mm) consists of four components, respectively: time module, a stimulus unit, microfluid compartment/drug tank & power supply (observable in hereinafter illustrations). Two stages of active drug delivery via a piston are shown in Figures 19 & 20. Specifically, Figure 19 displays the drug inside the electronic capsule, and in Figure 20 the medication during release/delivery can be seen.

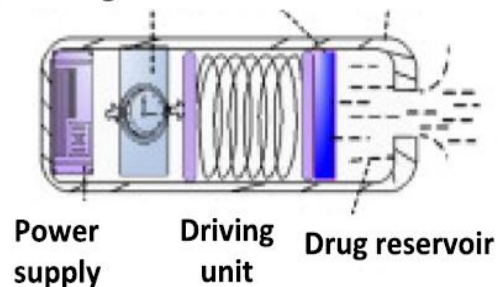
### (B-1)



**Figure 19:** Drug-Containing Capsule With Timer (Sharma & Associates, 2018: 6)

As demonstrated, this capsule is composed of multiple components, specifically: shell, piston, timer module, power supply, moving part and medicine storage. All components are integrated toward forming a swallowable capsule with a time-setting parameter interface plus an indicator signal for monitoring its working condition. After turning on the system, the desired fluid dose (maximum 0.5 ml) is released from the tank through a one-way valve activated by a piston (Figure 19). The proposed micro-tank system was tested both in-vitro (lab) and in living organisms. As a proof of concept, it can be claimed that this device is superior in accuracy as far as drug delivery time. Furthermore, it was discovered that gastrointestinal fluid has no effect on it, even though the proposed device can be further miniaturized.

### (B-2) Timing module Piston Shell



**Figure 20:** Timer Capsule During Drug Delivery Mode (Sharma & Associates, 2018: 6)

### Summary & Conclusion

Design and development of new materials and devices for medical purposes is among the most dynamic and exciting new fields of bioengineering and biotechnology and it is quite popular within the scientific community. Microelectromechanical systems (MEMS) are technological devices that can be defined as miniature mechanical and electromechanical elements. MEMS manufacturing technologies utilize high-performance processes that typically involve adding or subtracting two-dimensional layers onto a thin, sensitive surface, primarily grounded on photolithographic techniques and a variety of thin-film deposition techniques (with etching chemistry). The study's findings demonstrated that that these electromechanical capsules can be successful in both drug delivery and specialized treatments. In all the experiments listed and delineated within this study, it was discovered that while these capsules are successful, they can still achieve higher efficiency and effectiveness with a little further and additional laboratory study (even on living organisms), and their observed shortcomings can be eliminated. Consequently, this system can be incredibly useful, helpful and effective for patients suffering from certain spacial illnesses, who are moreover often at risk. Recent IDDS research has focused on MEMS, enabling researchers to meet most biomedical requisites. Particular essential target regions such as the colon, lung, prostate, kidney, diabetes and spinal cord injuries can be treated via the use of this system.

### References

- [1] Amer, S; Badawy, W (2005). An Integrated Platform for Bio-Analysis and Drug Delivery. Current Pharmaceutical Biotechnology, Volume 6, Number 1, pp. 57-64(8).
- [2] Cortegoso Valdivia, Pablo, Alexander R. Robertson, Nanne K. H. De Boer, Wojciech Marlicz and Anastasios Koulaouzidis(2021) An

- Overview of Robotic Capsules for Drug Delivery to the Gastrointestinal Tract. *Journal of clinical medicine. Clin. Med.* 2021, 10, 5791. <https://doi.org/10.3390/jcm10245791>
- [3] Elman, N, H. Ho Duc, and M. Cima, "An implantable MEMS drug delivery device for rapid delivery in ambulatory emergency care," *Biomedical Microdevices*, vol. 11, Jun. 2009, pp. 625-631
- [4] Khayeri, Sanaz (2018). Analysis & Design Of Small Wireless Capacitive Blood Pressure Sensors Utilizing MEMS Technology, Master's Thesis, Electrical & Computer Engineering College, Babol's Noshiravan University Of Technology.
- [5] Madan-Pasandi, Aysaan (2016). Study Of Mechanical Behavior Of Drug Injection Micropump With Circular Diaphragm Utilizing Coupling Stress Theory. Master's Thesis, Technical-Engineering Department, Electrical & Electronic Engineering College, Urmia University.
- [6] Maloney, John M.(2003). An implantable Microfabricated drug delivery system. 2003 ASME International Mechanical Engineering Congress. Washington, D.C., November 15–21, 2003
- [7] Maloney, J, M. Uhland, S. A. Polito, B. F. Sheppard, N. . Pelta, C. M and J. T. Santini,(2005)
- "Electrothermally activated microchips for implantable drug delivery and biosensing," *Journal of Controlled Release*, vol. 109, pp. 244-255.
- [8] Sharma T. Sanjay , Wan Zhou , Maowei Dou , Hamed Tavakoli, LeiMa, Feng Xu, XiuJun Li(2018). Recent advances of controlled drug delivery using microfluidic platforms. *Advanced Drug Delivery Reviews* 128 (2018) 3–28.. Elsevier
- [9] Wilding, P, Lan. Connor, H,A (2000). Development of a new engineering-based capsule for human drug absorption studies, *PSTT* 3
- [10] Xitian Pi , Hongying Liu, Kang Wei, Yulin Lin, Xiaolin Zheng, Zhiyu Wen (2009). A novel remote controlled capsule for site-specific drug delivery in human GI tract. *International Journal of Pharmaceutics* 382 (2009) 160–164. Elsevier.
- [11] Xitian Pi ,Yulin Lin, Kang Wei, Hongying Liu, Gang Wang, Xiaolin Zheng, Zhiyu Wen,Deyu Li (2010). A novel micro-fabricated thruster for drug release in remote controlled capsule. *Sensors and Actuators A* 159 (2010) 227–232.Elsevier.

6/22/2023