



## Mechanical Ventilator Design for COVID-19 Patient with Resistive Belt Sensor

Mustefa Jibril

School of Electrical & Computer Engineering, Dire Dawa Institute of Technology, Dire Dawa, Ethiopia  
[mustefa.jibril@ddu.edu.et](mailto:mustefa.jibril@ddu.edu.et)

**Abstract:** A ventilator is a device that provides cool air by moving the air in or out of the lungs, inhaling a patient who is not fit to smell, or breathing properly. In this paper, a resistive chest belt sensor-based mechanical ventilator is designed to provide the COVID-19 patient with the volume of air you need to deliver with the expansion of the patient's chest in need of more air. The resistive band sensor senses the expansion of the patient's chest and controls the solenoid valve attached to the oxygen compressor. The function of the respirator is tested with the MATLAB / Simulink tool with the help of a Proportional Integral Derivative (PID) Controller and a promising result obtained. [Mustefa Jibril. Baamer. **Mechanical Ventilator Design for COVID-19 Patient with Resistive Belt Sensor**. *Life Sci J* 2021;18(10):6-10] ISSN 1097-8135 (print); ISSN 2372-613X (online) <http://www.lifesciencesite.com>. 2. doi:[10.7537/marlsj181021.02](https://doi.org/10.7537/marlsj181021.02).

**Keywords:** Ventilator, Resistive, Proportional Integral Derivative, COVID-19

### 1. 1. Introduction

Ventilators are machines controlled by a modern microchip; however, patients can also be ventilated with a basic, hand-operated packet cover [1]. Ventilators are widely used in orthopedic, home-based medicine, and critical medicine (as independent units), and anesthesiology (as part of a lubricant) [2-3].

Ventilators are now called "breathing apparatus", a term often used for them in the 1950s (especially "bird's respirator"). However, modern emergency medicine and clinical printing use a "breathing machine" to refer to a protective face mask [4 - 5].

In its simplest design, a well-ventilated ventilator includes a ventilator, air and oxygen equipment, several valves and tubes, and a usable or easy-to-use "patient" [6]. The air intake is ventilated several times per minute to move the air in the room, or size, a combination of air/oxygen to the patient. If a turbine is used, the compressor pushes air through a ventilator, with a flow valve change strain to meet the patient's clear limits. When excessive pressure is transmitted to the patient, the patient will breathe inactively due to fluctuations in the lungs, the inhaled air is usually transmitted through a single directional valve within the patient circuit called the patient complex.

Ventilators can also be provided with patient monitoring and awareness parameters related to patients (e.g., compression factor, volume, and distribution) and air function (e.g. airflow, power failure, mechanical shock), stabilizing batteries,

oxygen tanks, and controller. The pneumatic framework is these days is regularly inserted by a PC-controlled turbopump [7].

Current ventilators are electrically ventilated with a small inserted frame to allow for careful adjustment of the pressures and distribution signals to the needs of each patient [8]. Adjusted and effective breathing apparatus makes the cool air dignified and appealing to the patient. In Canada and the United States, respiratory technicians are responsible for adjusting these settings, while biomedical specialists respond with maintenance. In the United Kingdom and Europe, the management of patient communication with a respirator is eliminated by primary care staff [9].

Since frustration can lead to death, air vents are provided with the basic components of life, and protection must be taken to ensure that they are especially strong, including their strength. Disruption is depleted of energy to support a sufficient amount of CO<sub>2</sub> depletion to maintain a stable pH without the aid of machinery, muscle fatigue, or severe dyspnea. [10] Mechanical ventilators are therefore carefully designed so that no single sign of embarrassment could put a patient at risk. They may be equipped with hand-held braces to power the hand-operated breathing force, (for example, a mechanical vacuum cleaner). They may also have well-ventilated, open-air valves without being able to move as an enemy of the patient's unrestricted respiratory valve [11]. A few frames are also fitted with packed fuel tanks, air blowers, or reinforcing batteries to provide cool air in the event of an accidental power outage or gas

supply, and operating or requesting assistance if its components or system are shortened.

**2. Mathematical Modelling**

**2.1 How is it work**

At a normal patient breath, the reference resistance from the potentiometer R is given as input. When the patient breathing increases or become deep, the

resistance of the belt increases because of that the voltage given to the solenoid valve increases so that more air volume will get out from the solenoid valve. The solenoid valve is attached to the oxygen compressor and the amount of air volume is controlled by the solenoid valve. The block diagram of the ventilator system is shown in Figure 1 below.

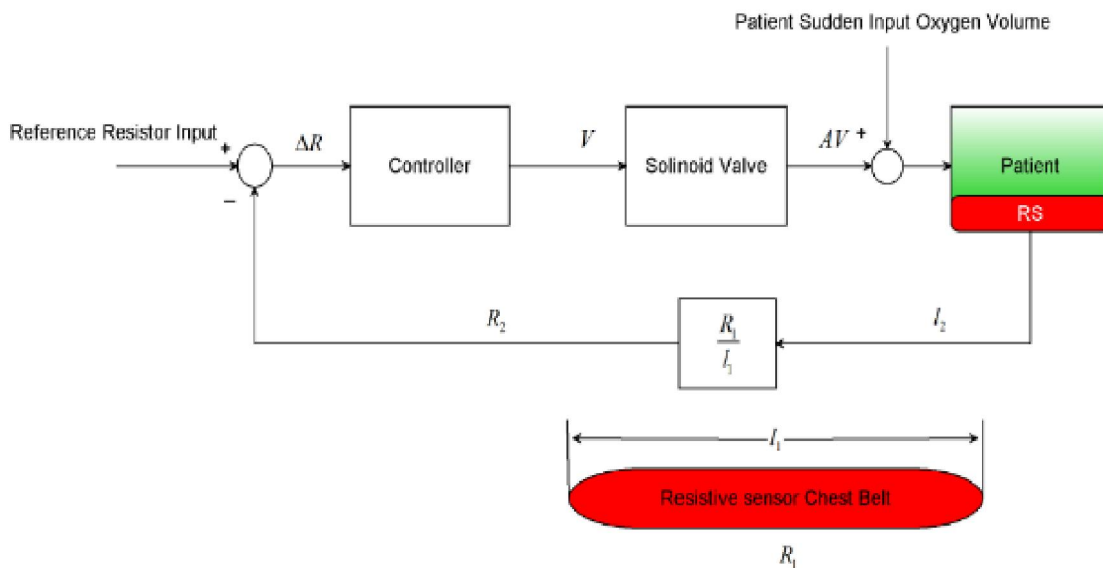

Figure 1 block diagram of the ventilator system

**2.2 Resistive Sensor Chest Belt**

The resistive chest belt is simply a belt with a resistor attached to it and when the patient's air breath increases the belt expands and the resistor length will be changed and also the resistance of the belt increases.

**2.3 Resistive Belt Modeling**

The resistance of the belt changes when the patient's air volume inhale increases. The change in resistance occurs because of the change in the length of the belt. From the equation of resistance

$$R = \frac{\rho l}{A} \tag{1}$$

The resistivity and the area are constants

$$\frac{R}{l} = \frac{\rho}{A} = C \tag{2}$$

When the patient breathing increases the length of the resistive belt increases and becomes

$$\frac{R_1}{l_1} = \frac{R_2}{l_2} \tag{3}$$

From this equation, we can simply get the new patient volume resistance as

$$\frac{R_1 x l_2}{l_1} = R_2 \tag{4}$$

**2.4 Modeling of the Solenoid Valve**

The solenoid valve is the device that controls the airflow from the oxygen compressor to the patient. Let the solenoid valve represented by the first-order system

$$G(s) = \frac{5}{10s + 10} \tag{5}$$

Where G(s) is the transfer function between the input voltage and output air volume.

**2.5 Tidal Volume (TV)**

It is a measure of air that can be inhaled or inhaled during a single breathing cycle]. This produces the elements that focus on the respiratory system, the respiratory muscles, and the machines that separate the lungs and chest. The average adult growth rate is 10% of the critical limit (VC), approximately 300-500ml (6 - 8 ml/kg); however, it can rise to half of the VC in respiratory failure.

The relationship between patient crying air volume and band length is considered equilibrium. The chest width of an adult aged b / n 30-35- and 1.55-meters high is 0.8 meters.

For normal berating the relationship becomes

$$\frac{l}{AV} = \frac{0.8}{500} = 0.0016$$

$$l = 0.0016AV$$

### 2.6 Ventilator Air Duct Design

The air duct acts as air input and output and this system acts as a ventilator and the system diagram is shown in Figure 2 below.

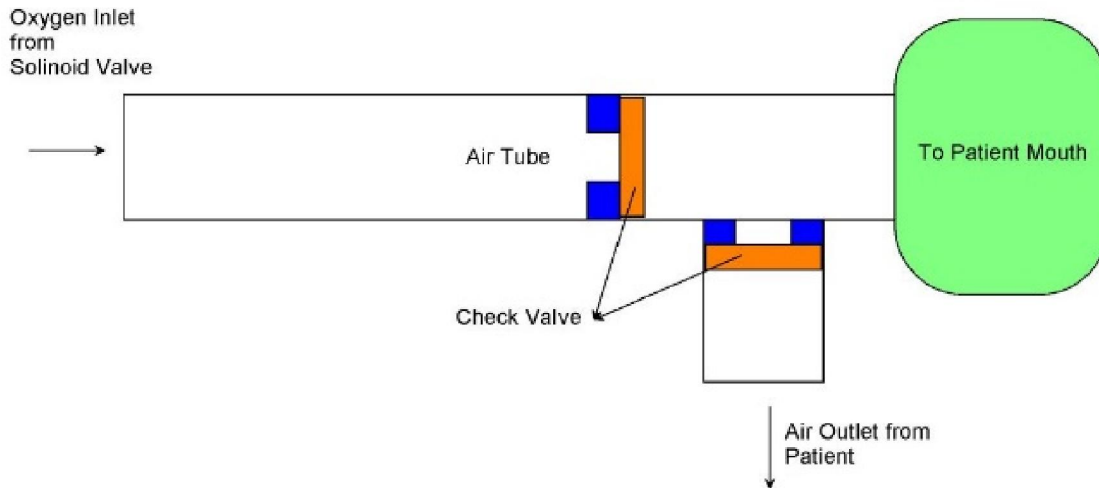

Figure 2 Ventilator air duct model

The system has 2 check valves to control airflow in and airflow out as shown in Figure 2 above.

### 3. Proposed Controller Design

#### 3.1 PID Controller

A PID controller is a device used in machine control systems to control temperature, distribution, compression factor, speed, and other rotation objects. PID controllers (less important key) use the input circuit control tool input and it is the most accurate and stable control.

PID control is a basic way of driving an outline to a specific area or level. It is a common universal method such as temperature control and application in massive and artificial cycles such as robot design. PID controls use circle control closures to keep the actual yield from the cycle as close to the target or setpoint yield as can be expected.

### 4. Result and Discussion

#### 4.1 System Parameters

Copper has a resistivity of 0.0171 Ohm · mm<sup>2</sup>/m and is, therefore, one of the best conductors for electric current and mentioned above the belt length is 0.8m

and let the belt area becomes 40 mm<sup>2</sup>. Therefore, the normal air volume resistance becomes

$$R_{normal} = \frac{\rho l}{A_{belt}} = \frac{(0.0171 ohm)(0.8m)}{40 mm^2} = 0.000342$$

Therefore, the setpoint resistance becomes 0.000342

#### 4.2 Simulink Block Diagram

The Simulink block diagram of the mechanical ventilator is shown in Figure 3 below. Here in this system, a PID controller with an auto-tuner system, a solenoid valve transfer function, a sudden patient air volume, air volume to change in belt length, length to resistance converter, inhale air volume scope, and output resistance scope blocks are shown below.

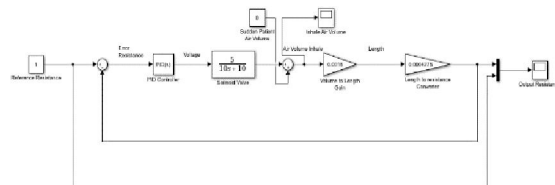

Figure 3 Simulink block diagram

### 4.3 Simulation of the Actual Belt Resistance to Reference Resistance with Patient Normal Breathing

The simulation result of the patient normal breathing for a given reference resistance output actual resistance and air volume inhale are shown in Figure 4 and Figure 5 respectively.

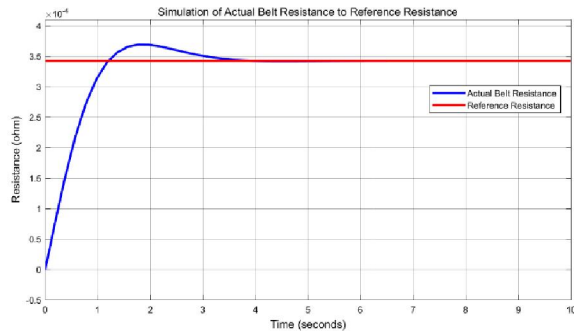

Figure 4 Simulation result of the actual and reference resistances

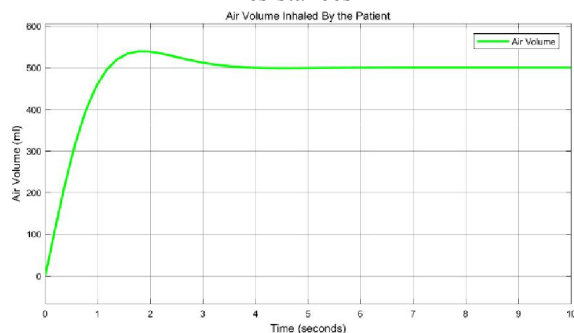

Figure 5 Normal breathing air volume

The simulation result shows that the reference and actual resistances are the same and there is no error resistance signal and the solenoid valve will continue to give the patient an amount of air volume of 500 ml of oxygen volume.

### 4.4 Simulation of the Actual Belt Resistance to Reference Resistance with Patient Sudden Air Volume Inhale

The simulation result of the patient's sudden air volume inhale of 300 ml for a given reference resistance output actual resistance and air volume inhale are shown in Figure 6 and Figure 7 respectively.

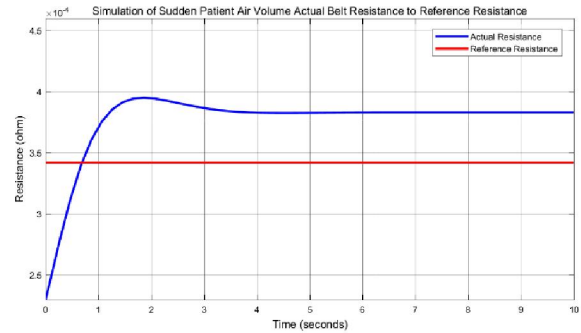

Figure 6 Simulation result of the actual and reference resistances for a sudden air volume inhaled by the patient

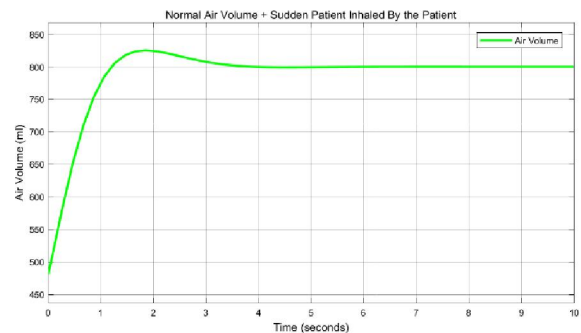

Figure 7 Sudden breathing air volume

The simulation result shows that the actual resistances increase because of the increase in chest diameter or length of the belt and there is an error resistance signal which adjusted the solenoid valve to give the patient a sufficient oxygen volume and the patient will continue to breathe with an air volume of 800 ml of oxygen.

## 5. Conclusion

In this paper, a resistive belt sensor-based mechanical ventilator is designed for COVID-19 patients successfully. A resistive band sensor is attached to the patient's chest to feel the band's resistance while the patient is breathing. The PID controller is built into a mechanical respirator to test system response. The system response test was performed with the help of MATLAB / Simulink for a patient with normal breathing and sudden respiratory changes. Imitation results indicate that the system has a better response and for future work, the performance of the system can be improved if controlled by another controller.

## Reference

- [1]. Mustefa Jibril Taha, F. B. Kibret, V. Ramayya, and B. A. Zeru, "Design and evaluation of solar parabolic trough collector system integrated with

- conventional oil boiler,” *Arch. Electr. Eng.*, vol. 70, no. No 3, pp. 657–673, 2021, doi: 10.24425/aee.2021.137580.
- [2]. Tirupati R, Botha J. Fighting a pandemic with mechanical ventilators. *Intern Med J.* 2020;50(8):1019-1020. doi:10.1111/imj.14951
- [3]. Wunsch H, Hill AD, Bosch N, et al. Comparison of 2 Triage Scoring Guidelines for Allocation of Mechanical Ventilators. *JAMA Netw Open.* 2020;3(12):e2029250. doi:10.1001/jamanetworkopen.2020.29250
- [4]. King WP, Amos J, Azer M, Baker D, Bashir R, et al. (2020) Emergency ventilator for COVID-19. *PLOS ONE* 15(12): e0244963. <https://doi.org/10.1371/journal.pone.0244963>
- [5]. Ferguson NM, Laydon D, Nedjati-Gilani G, Imai N, Ainslie K, Baguelin M, et al. Impact of non-pharmaceutical interventions (NPIs) to reduce COVID-19 mortality and healthcare demand. *Spiral Imp Coll London’s Repos.* 2020; 1–20. pmid:32270376
- [6]. Jiri Hromadka, Nurul N. Mohd Hazlan, Francisco U. Hernandez, Ricardo Correia, A. Norris, Stephen P Morgan, Sergiy Korposh, Simultaneous in situ temperature and relative humidity monitoring in mechanical ventilators using an array of functionalized optical fiber long-period grating sensors, *Sensors, and Actuators B: Chemical*, Volume 286, 2019, Pages 306-314.
- [7]. Badnjevic, Almira; b; c | Gurbeta, Lejlai; b | Jimenez, Elvira Ruizd | Iadanza, Ernestoe;, *Technology and Health Care*, vol. 25, no. 2, pp. 237-250, 2017
- [8]. Chatburn R.L. El-Khatib M. Mireles-Cabodevila E. A taxonomy for mechanical ventilation: 10 fundamental maxims. *Respir Care.* 2014 Nov; 59: 1747-1763
- [9]. Esteban A. Ferguson N.D. Meade M.O. et al. Evolution of mechanical ventilation in response to clinical research. *Am J Respir Crit Care Med.* 2008; 177: 170-177.
- [10]. Hick JL, O’Laughlin DT. Concept of operations for triage of mechanical ventilation in an epidemic. *Acad Emerg Med.* 2006;13(2):223–9.
- [11]. Anne Battisti, Didier Tassaux, Jean-Paul Janssens, Jean-Bernard Michotte, Samir Jaber, Philippe Jolliet, Performance Characteristics of 10 Home Mechanical Ventilators in Pressure-Support Mode, *Chest*, Volume 127, Issue 5, 2005, Pages 1784-1792.
- [12]. Branson R.D. Chatburn R.L. Technical description and classification of modes of ventilator operation. *Respir Care.* 1992; 37: 1026-1044

10/7/2021